

DATA SHEET

BUK107-50DL PowerMOS transistor Logic level TOPFET

Product specification
Supersedes data of September 1994
File under Discrete Semiconductors, SC13a

March 1997

PowerMOS transistor Logic level TOPFET

BUK107-50DL

DESCRIPTION

Monolithic overload protected logic level power MOSFET in a surface mount plastic envelope, intended as a general purpose switch for automotive systems and other applications.

APPLICATIONS

- General controller for driving
- lamps
 - small motors
 - solenoids

FEATURES

- Vertical power DMOS output stage
- Overload protected up to 85°C ambient
- Overload protection by current limiting and overtemperature sensing
- Latched overload protection reset by input
- 5 V logic compatible input level
- Control of power MOSFET and supply of overload protection circuits derived from input
- Low operating input current permits direct drive by micro-controller
- ESD protection on all pins
- Overvoltage clamping for turn off of inductive loads

QUICK REFERENCE DATA

SYMBOL	PARAMETER	MAX.	UNIT
V_{DS}	Continuous drain source voltage	50	V
I_D	Continuous drain current	0.7	A
P_D	Total power dissipation	1.8	W
T_j	Continuous junction temperature	150	°C
$R_{DS(ON)}$	Drain-source on-state resistance	200	mΩ

FUNCTIONAL BLOCK DIAGRAM

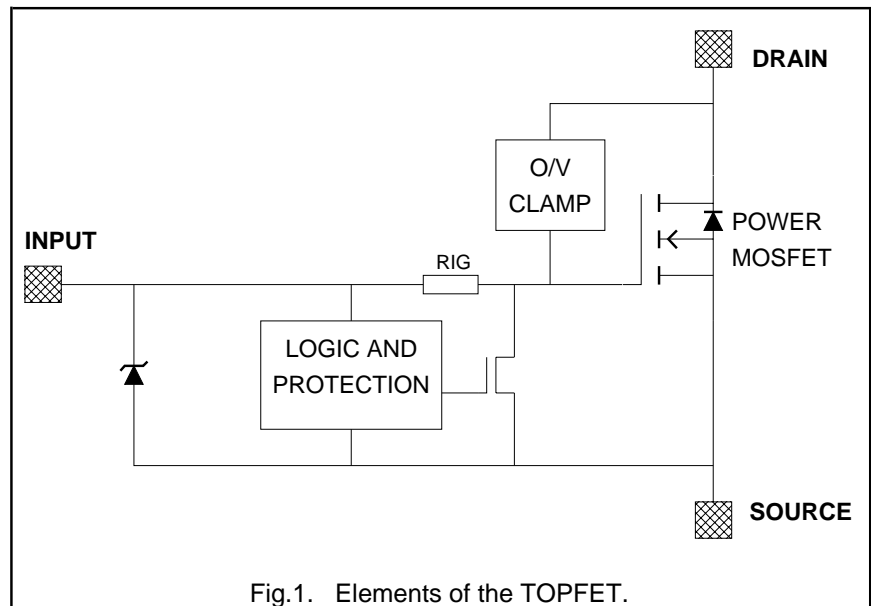

PINNING - SOT223

PIN	DESCRIPTION
1	input
2	drain
3	source
4	drain (tab)

PIN CONFIGURATION

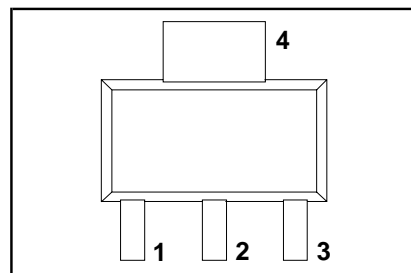

SYMBOL

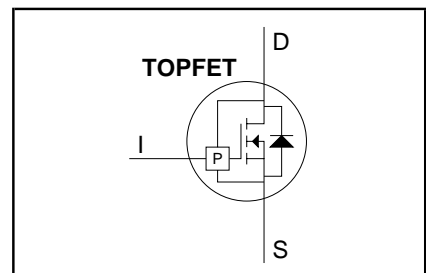

PowerMOS transistor

Logic level TOPFET

BUK107-50DL

LIMITING VALUES

Limiting values in accordance with the Absolute Maximum System (IEC 134)

SYMBOL	PARAMETER	CONDITIONS	MIN.	MAX.	UNIT
V_{DS}	Continuous drain source voltage ¹	-	-	50	V
I_D	Continuous drain current ²	-	-	self limiting	A
I_I	Continuous input current	clamping	-	3	mA
I_{IRM}	Non-repetitive peak input current	$t_p \leq 1$ ms	-	10	mA
P_D	Total power dissipation	$T_{amb} = 25$ °C	-	1.8	W
T_{stg}	Storage temperature	-	-55	150	°C
T_j	Continuous junction temperature	normal operation ³	-	150	°C

ESD LIMITING VALUE

SYMBOL	PARAMETER	CONDITIONS	MIN.	MAX.	UNIT
V_C	Electrostatic discharge capacitor voltage	Human body model; C = 250 pF; R = 1.5 k Ω	-	2	kV

OVERVOLTAGE CLAMPING LIMITING VALUES

At a drain source voltage above 50 V the power MOSFET is actively turned on to clamp overvoltage transients.

SYMBOL	PARAMETER	CONDITIONS	MIN.	MAX.	UNIT
E_{DSM}	Non-repetitive clamping energy	$T_b \leq 25$ °C; $I_{DM} < I_{D(lim)}$; inductive load	-	100	mJ
E_{DRM}	Repetitive clamping energy	$T_b \leq 75$ °C; $I_{DM} = 50$ mA; f = 250 Hz	-	4	mJ

OVERLOAD PROTECTION LIMITING VALUES

With the protection supply provided via the input pin, TOPFET can protect itself from short circuit loads. Overload protection operates by means of drain current limiting and activating the overtemperature protection.

SYMBOL	PARAMETER	CONDITIONS	MIN.	MAX.	UNIT
V_{DDP}	Protected drain source supply voltage	$V_{IS} = 5$ V	-	35	V
		$V_{IS} = 4$ V	-	16	V

OVERLOAD PROTECTION CHARACTERISTICS

TOPFET switches off to protect itself when there is an overload fault condition. It remains latched off until reset by the input.

SYMBOL	PARAMETER	CONDITIONS	MIN.	TYP.	MAX.	UNIT
	Overload protection					
$I_{D(lim)}$	Drain current limiting	$V_{IS} = 5$ V	0.7	1.1	1.5	A
$T_{j(TO)}$	Overtemperature protection Threshold junction temperature	only in drain current limiting $V_{IS} = 5$ V	100	130	160	°C

¹ Prior to the onset of overvoltage clamping. For voltages above this value, safe operation is limited by the overvoltage clamping energy.

² Refer to OVERLOAD PROTECTION CHARACTERISTICS.

³ Not in an overload condition with drain current limiting.

PowerMOS transistor

Logic level TOPFET

BUK107-50DL

THERMAL CHARACTERISTICS

SYMBOL	PARAMETER	CONDITIONS	MIN.	TYP.	MAX.	UNIT
$R_{th\ j-sp}$	Thermal resistance Junction to solder point		-	12	18	K/W
$R_{th\ j-b}$	Junction to board ¹	Mounted on any PCB	-	40	-	K/W
$R_{th\ j-a}$	Junction to ambient	Mounted on PCB of fig. 19	-	-	70	K/W

STATIC CHARACTERISTICS

$T_b = 25\text{ °C}$ unless otherwise specified

SYMBOL	PARAMETER	CONDITIONS	MIN.	TYP.	MAX.	UNIT
$V_{(CL)DSS}$	Drain-source clamping voltage	$V_{IS} = 0\text{ V}; I_D = 10\text{ mA}$	50	55	-	V
$V_{(CL)DSS}$	Drain-source clamping voltage	$V_{IS} = 0\text{ V}; I_{DM} = 200\text{ mA};$ $t_p \leq 300\text{ }\mu\text{s}; \delta \leq 0.01$	-	56	70	V
I_{DSS}	Off-state drain current	$V_{DS} = 45\text{ V}; V_{IS} = 0\text{ V}$	-	0.5	2	μA
I_{DSS}	Off-state drain current	$V_{DS} = 50\text{ V}; V_{IS} = 0\text{ V}$	-	1	20	μA
I_{DSS}	Off-state drain current	$V_{DS} = 40\text{ V}; V_{IS} = 0\text{ V}; T_j = 100\text{ °C}$	-	10	100	μA
$R_{DS(ON)}$	Drain-source on-state resistance ²	$V_{IS} = 5\text{ V}; I_{DM} = 100\text{ mA};$ $t_p \leq 300\text{ }\mu\text{s}; \delta \leq 0.01$	-	150	200	$\text{m}\Omega$

INPUT CHARACTERISTICS

$T_b = 25\text{ °C}$ unless otherwise specified. The supply for the logic and overload protection is taken from the input.

SYMBOL	PARAMETER	CONDITIONS	MIN.	TYP.	MAX.	UNIT
$V_{IS(TO)}$	Input threshold voltage	$V_{DS} = 5\text{ V}; I_D = 1\text{ mA}$	1.7	2.2	2.7	V
I_{IS}	Input supply current	normal operation;	$V_{IS} = 5\text{ V}$ -	330	450	μA
I_{ISL}	Input supply current	protection latched;	$V_{IS} = 4\text{ V}$ $V_{IS} = 5\text{ V}$ $V_{IS} = 3.5\text{ V}$	170	270	μA
I_{ISL}	Input supply current		-	500	650	μA
I_{ISL}	Input supply current		-	250	400	μA
V_{ISR}	Protection latch reset voltage ³		1	2.2	3.5	V
$V_{(CL)IS}$	Input clamping voltage	$I_l = 1.5\text{ mA}$	6	7.5	-	V
R_{IG}	Input series resistance	to gate of power MOSFET	-	33	-	$\text{k}\Omega$

SWITCHING CHARACTERISTICS

$T_{amb} = 25\text{ °C}$; resistive load $R_L = 50\text{ }\Omega$; adjust V_{DD} to obtain $I_D = 250\text{ mA}$; refer to test circuit and waveforms

SYMBOL	PARAMETER	CONDITIONS	MIN.	TYP.	MAX.	UNIT
$t_{d\ on}$	Turn-on delay time	$V_{IS} = 0\text{ V}$ to $V_{IS} = 5\text{ V}$	-	8	-	μs
t_r	Rise time		-	30	-	μs
$t_{d\ off}$	Turn-off delay time	$V_{IS} = 5\text{ V}$ to $V_{IS} = 0\text{ V}$	-	3	-	μs
t_f	Fall time		-	6	-	μs

¹ Temperature measured 1.3 mm from tab.

² Continuous input voltage. The specified pulse width is for the drain current.

³ The input voltage below which the overload protection circuits will be reset.

PowerMOS transistor
Logic level TOPFET

BUK107-50DL

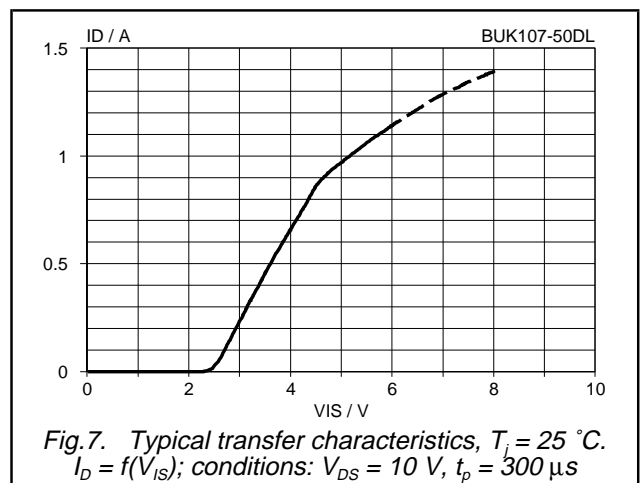
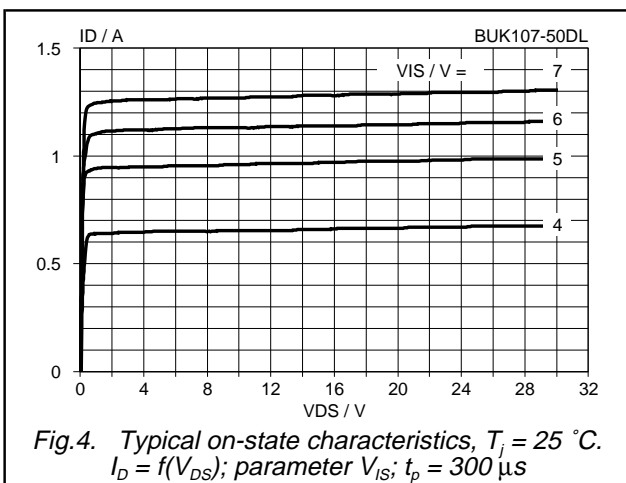
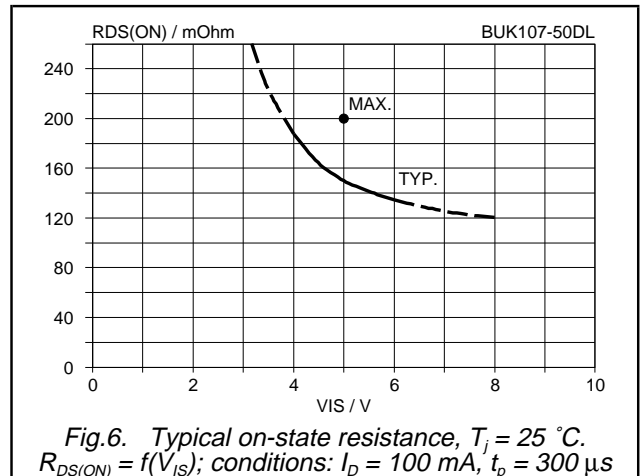
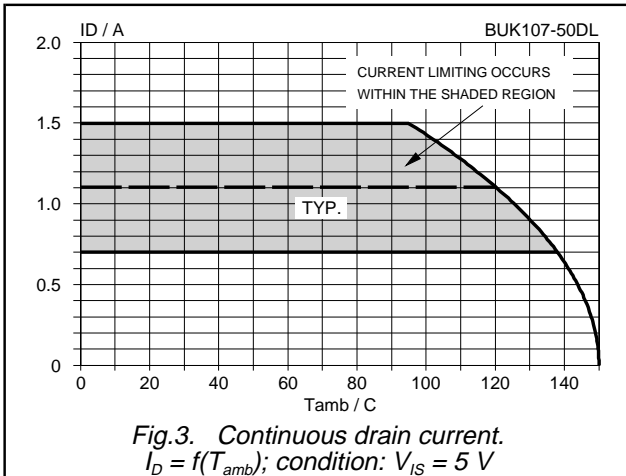
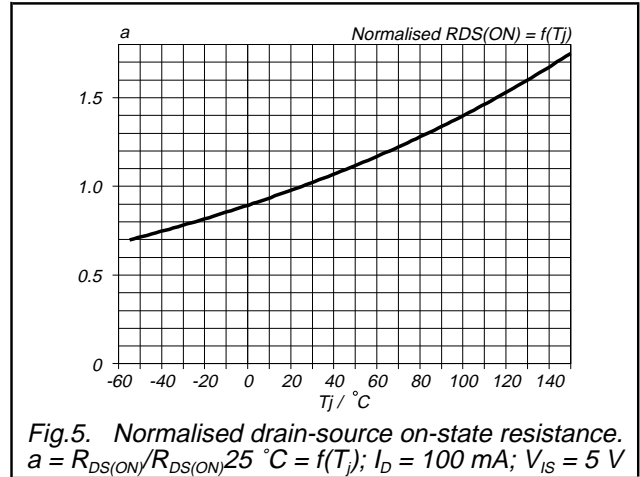
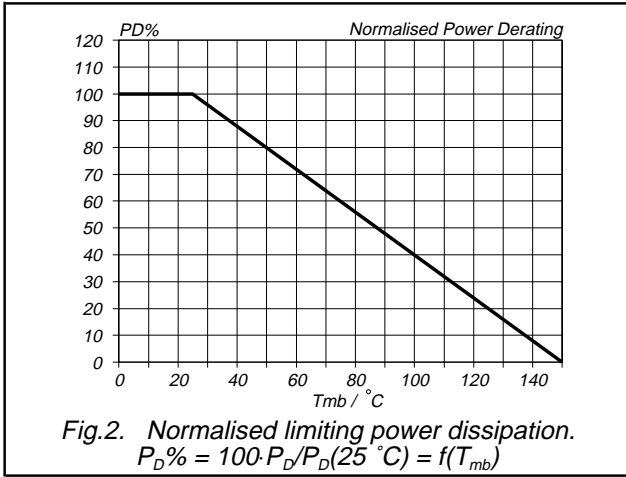

PowerMOS transistor
Logic level TOPFET

BUK107-50DL

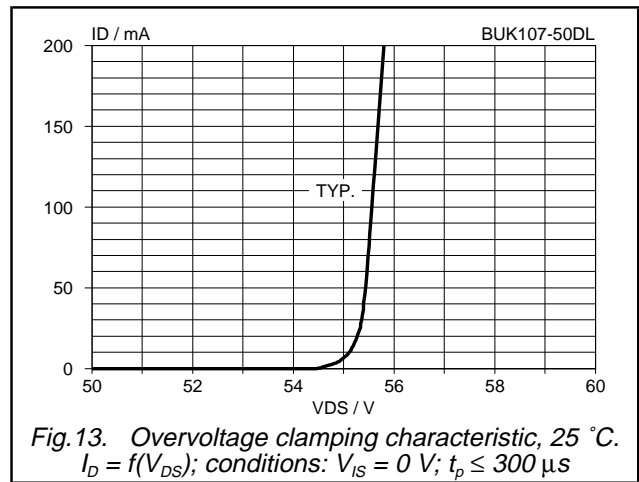
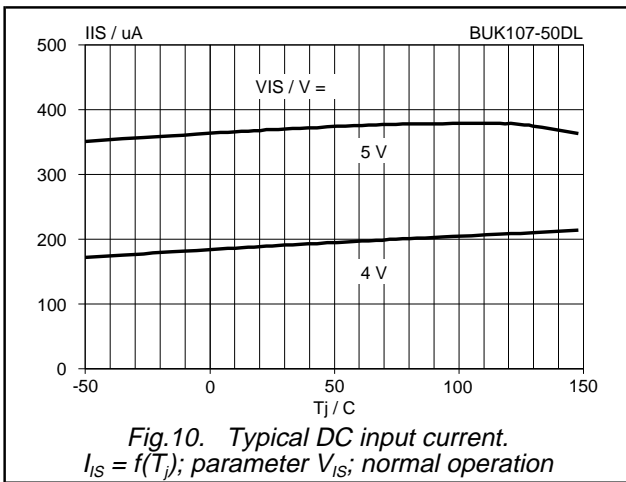
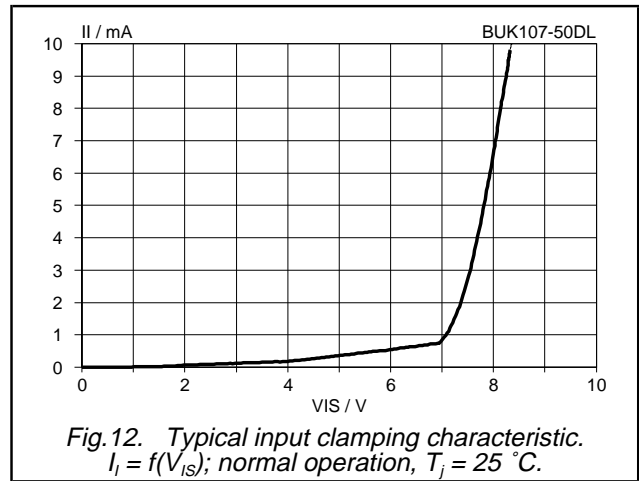
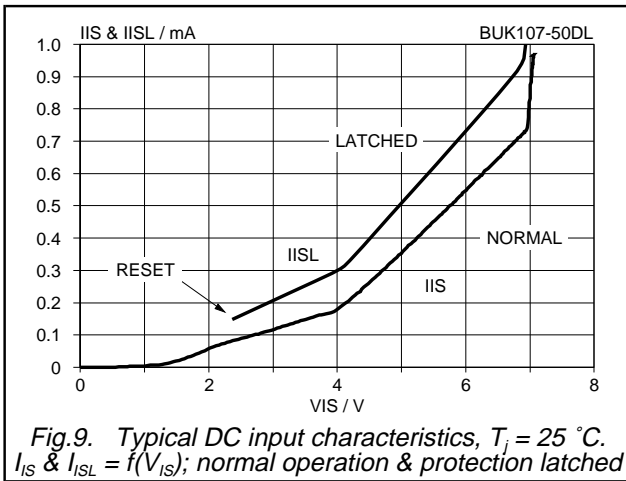
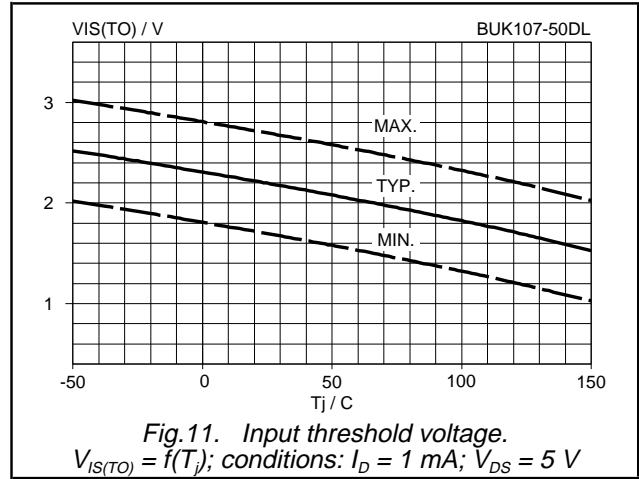
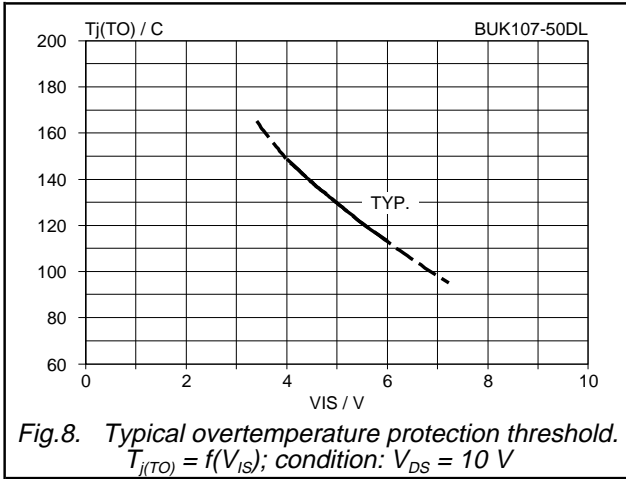

PowerMOS transistor
Logic level TOPFET

BUK107-50DL

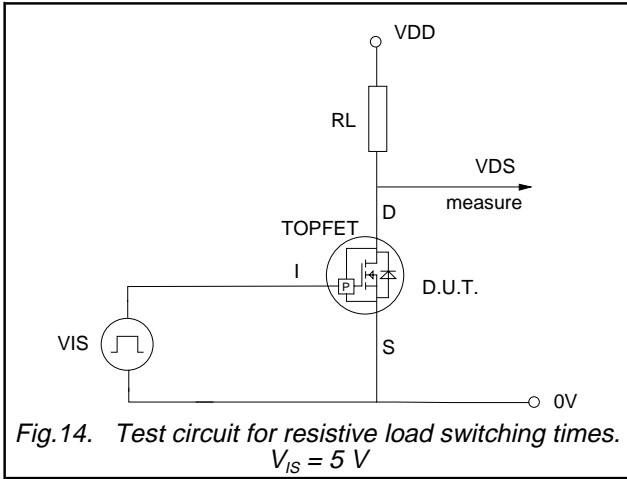

Fig.14. Test circuit for resistive load switching times.
 $V_{IS} = 5\text{ V}$

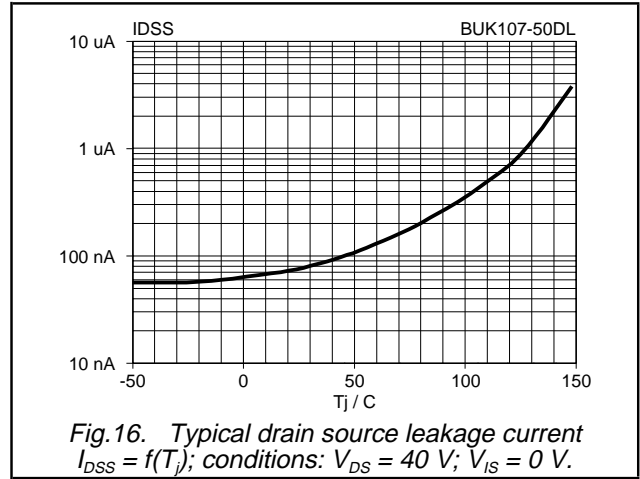

Fig.16. Typical drain source leakage current $I_{DSS} = f(T_j)$; conditions: $V_{DS} = 40\text{ V}$; $V_{IS} = 0\text{ V}$.

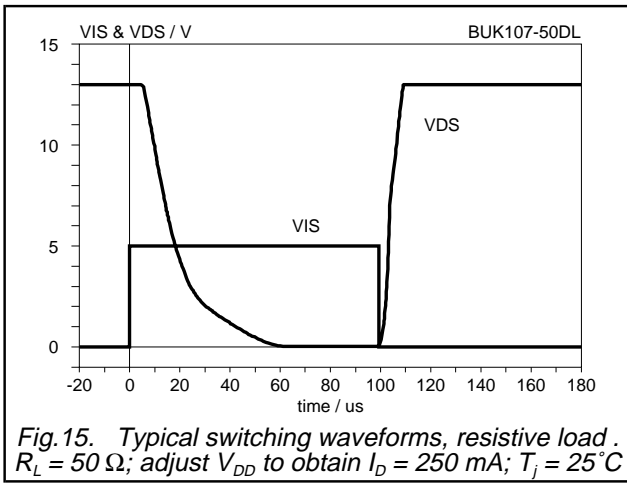

Fig.15. Typical switching waveforms, resistive load .
 $R_L = 50\ \Omega$; adjust V_{DD} to obtain $I_D = 250\text{ mA}$; $T_j = 25^\circ\text{C}$

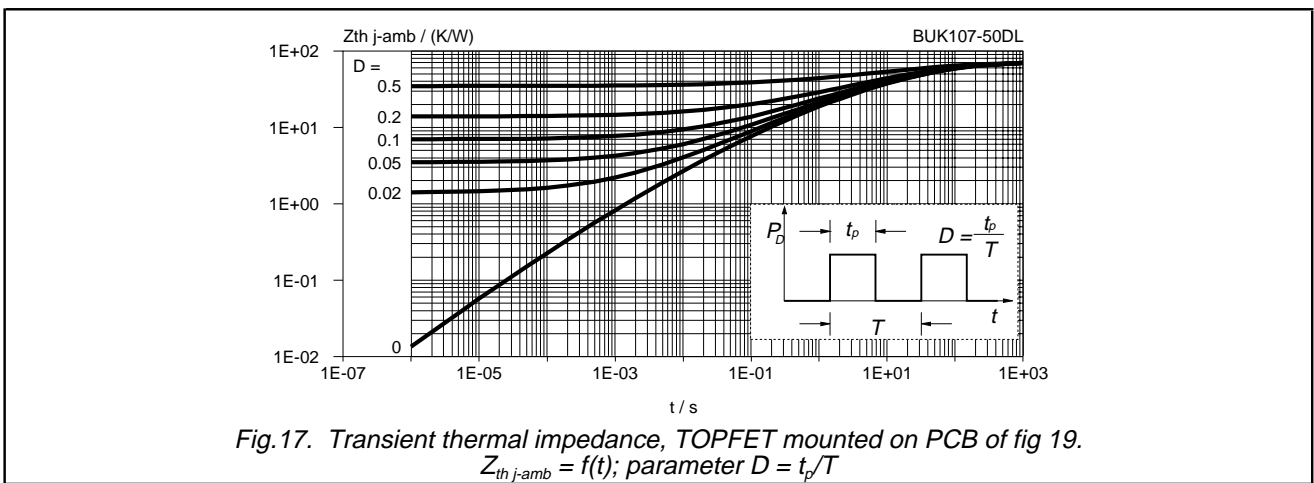
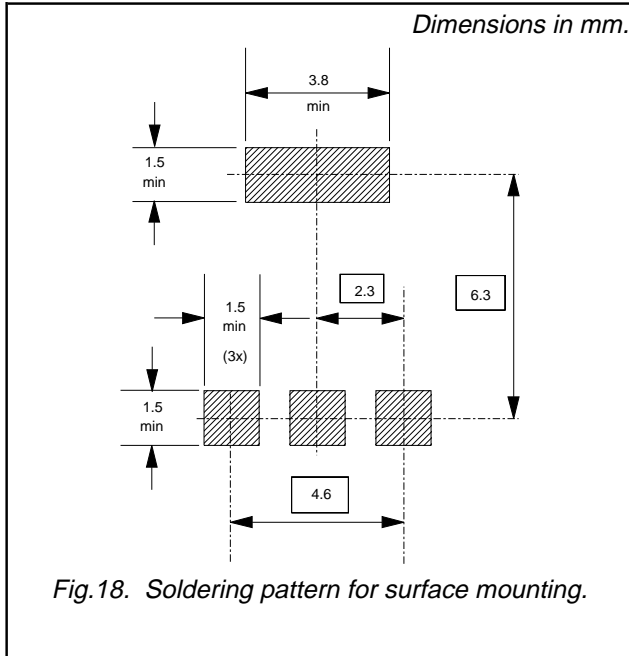

Fig.17. Transient thermal impedance, TOPFET mounted on PCB of fig 19.
 $Z_{th\ j-amb} = f(t)$; parameter $D = t_p/T$

PowerMOS transistor
Logic level TOPFET

BUK107-50DL

MOUNTING INSTRUCTIONS



PRINTED CIRCUIT BOARD

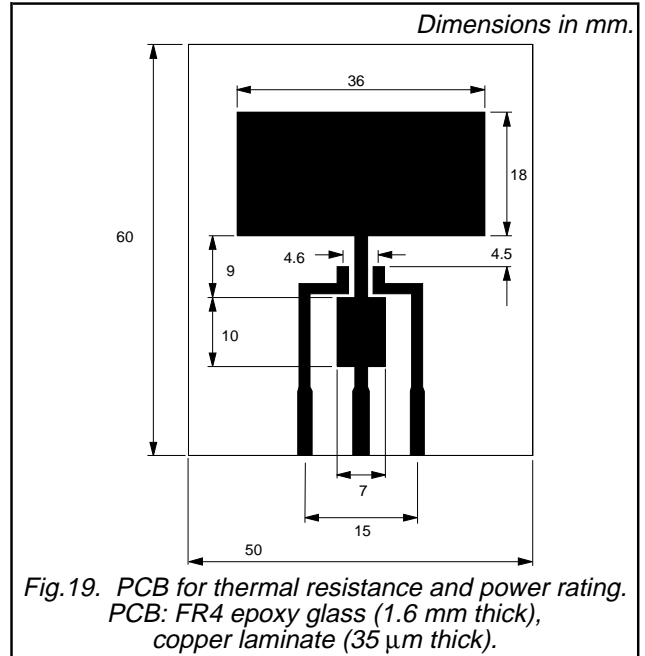

PowerMOS transistor
Logic level TOPFET

BUK107-50DL

MECHANICAL DATA

Dimensions in mm

Net Mass: 0.11 g

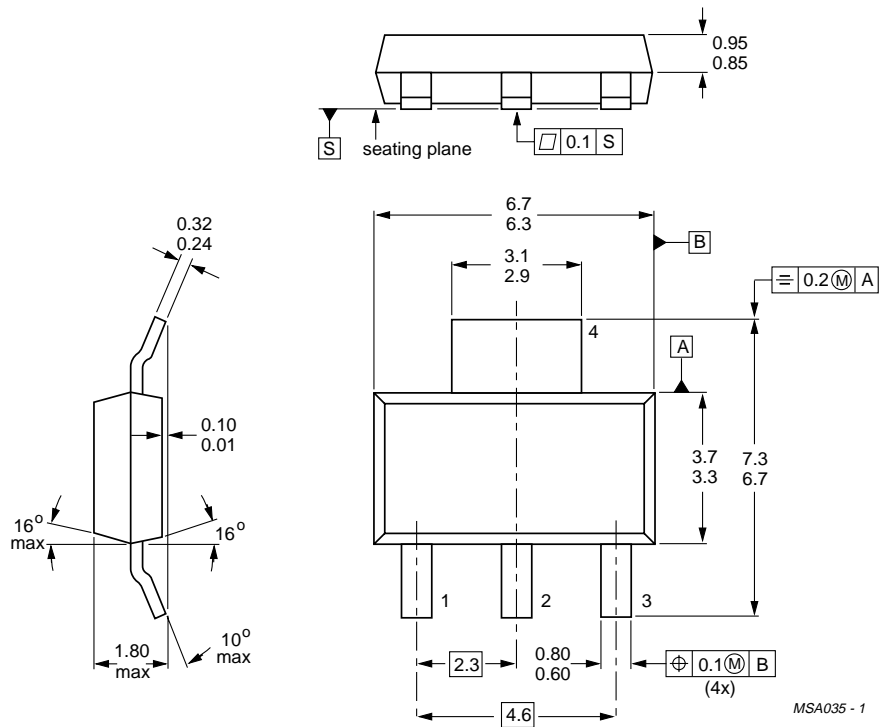

Fig.20. SOT223 surface mounting package¹.

¹ For further information, refer to surface mounting instructions for SOT223 envelope. Epoxy meets UL94 V0 at 1/8".

PowerMOS transistor
Logic level TOPFET

BUK107-50DL**DEFINITIONS**

Data sheet status	
Objective specification	This data sheet contains target or goal specifications for product development.
Preliminary specification	This data sheet contains preliminary data; supplementary data may be published later.
Product specification	This data sheet contains final product specifications.
Limiting values	
Limiting values are given in accordance with the Absolute Maximum Rating System (IEC 134). Stress above one or more of the limiting values may cause permanent damage to the device. These are stress ratings only and operation of the device at these or at any other conditions above those given in the Characteristics sections of this specification is not implied. Exposure to limiting values for extended periods may affect device reliability.	
Application information	
Where application information is given, it is advisory and does not form part of the specification.	
© Philips Electronics N.V. 1997	
All rights are reserved. Reproduction in whole or in part is prohibited without the prior written consent of the copyright owner.	
The information presented in this document does not form part of any quotation or contract, it is believed to be accurate and reliable and may be changed without notice. No liability will be accepted by the publisher for any consequence of its use. Publication thereof does not convey nor imply any license under patent or other industrial or intellectual property rights.	

LIFE SUPPORT APPLICATIONS

These products are not designed for use in life support appliances, devices or systems where malfunction of these products can be reasonably expected to result in personal injury. Philips customers using or selling these products for use in such applications do so at their own risk and agree to fully indemnify Philips for any damages resulting from such improper use or sale.

PowerMOS transistor
Logic level TOPFET

BUK107-50DL

NOTES

Philips Semiconductors – a worldwide company

Argentina: see South America

Australia: 34 Waterloo Road, NORTH RYDE, NSW 2113,
Tel. +61 2 9805 4455, Fax. +61 2 9805 4466

Austria: Computerstr. 6, A-1101 WIEN, P.O. Box 213,
Tel. +43 1 60 101, Fax. +43 1 60 101 1210

Belarus: Hotel Minsk Business Center, Bld. 3, r. 1211, Volodarski Str. 6,
220050 MINSK, Tel. +375 172 200 733, Fax. +375 172 200 773

Belgium: see The Netherlands

Brazil: see South America

Bulgaria: Philips Bulgaria Ltd., Energoproject, 15th floor,
51 James Bourchier Blvd., 1407 SOFIA,
Tel. +359 2 689 211, Fax. +359 2 689 102

Canada: PHILIPS SEMICONDUCTORS/COMPONENTS,
Tel. +1 800 234 7381

China/Hong Kong: 501 Hong Kong Industrial Technology Centre,
72 Tat Chee Avenue, Kowloon Tong, HONG KONG,
Tel. +852 2319 7888, Fax. +852 2319 7700

Colombia: see South America

Czech Republic: see Austria

Denmark: Prags Boulevard 80, PB 1919, DK-2300 COPENHAGEN S,
Tel. +45 32 88 2636, Fax. +45 31 57 0044

Finland: Sinikalliontie 3, FIN-02630 ESPOO,
Tel. +358 9 615800, Fax. +358 9 61580920

France: 4 Rue du Port-aux-Vins, BP317, 92156 SURESNES Cedex,
Tel. +33 1 40 99 6161, Fax. +33 1 40 99 6427

Germany: Hammerbrookstraße 69, D-20097 HAMBURG,
Tel. +49 40 23 53 60, Fax. +49 40 23 536 300

Greece: No. 15, 25th March Street, GR 17778 TAVROS/ATHENS,
Tel. +30 1 4894 339/239, Fax. +30 1 4814 240

Hungary: see Austria

India: Philips INDIA Ltd, Shivsagar Estate, A Block, Dr. Annie Besant Rd.
Worli, MUMBAI 400 018, Tel. +91 22 4938 541, Fax. +91 22 4938 722

Indonesia: see Singapore

Ireland: Newstead, Clonskeagh, DUBLIN 14,
Tel. +353 1 7640 000, Fax. +353 1 7640 200

Israel: RAPAC Electronics, 7 Kehilat Saloniki St, PO Box 18053,
TEL AVIV 61180, Tel. +972 3 645 0444, Fax. +972 3 649 1007

Italy: PHILIPS SEMICONDUCTORS, Piazza IV Novembre 3,
20124 MILANO, Tel. +39 2 6752 2531, Fax. +39 2 6752 2557

Japan: Philips Bldg 13-37, Kohnan 2-chome, Minato-ku, TOKYO 108,
Tel. +81 3 3740 5130, Fax. +81 3 3740 5077

Korea: Philips House, 260-199 Itaewon-dong, Yongsan-ku, SEOUL,
Tel. +82 2 709 1412, Fax. +82 2 709 1415

Malaysia: No. 76 Jalan Universiti, 46200 PETALING JAYA, SELANGOR,
Tel. +60 3 750 5214, Fax. +60 3 757 4880

Mexico: 5900 Gateway East, Suite 200, EL PASO, TEXAS 79905,
Tel. +9-5 800 234 7381

Middle East: see Italy

Netherlands: Postbus 90050, 5600 PB EINDHOVEN, Bldg. VB,
Tel. +31 40 27 82785, Fax. +31 40 27 88399

New Zealand: 2 Wagener Place, C.P.O. Box 1041, AUCKLAND,
Tel. +64 9 849 4160, Fax. +64 9 849 7811

Norway: Box 1, Manglerud 0612, OSLO,
Tel. +47 22 74 8000, Fax. +47 22 74 8341

Philippines: Philips Semiconductors Philippines Inc.,
106 Valero St. Salcedo Village, P.O. Box 2108 MCC, MAKATI,
Metro MANILA, Tel. +63 2 816 6380, Fax. +63 2 817 3474

Poland: Ul. Lukiska 10, PL 04-123 WARSZAWA,
Tel. +48 22 612 2831, Fax. +48 22 612 2327

Portugal: see Spain

Romania: see Italy

Russia: Philips Russia, Ul. Usatcheva 35A, 119048 MOSCOW,
Tel. +7 095 755 6918, Fax. +7 095 755 6919

Singapore: Lorong 1, Toa Payoh, SINGAPORE 1231,
Tel. +65 350 2538, Fax. +65 251 6500

Slovakia: see Austria

Slovenia: see Italy

South Africa: S.A. PHILIPS Pty Ltd., 195-215 Main Road Martindale,
2092 JOHANNESBURG, P.O. Box 7430 Johannesburg 2000,
Tel. +27 11 470 5911, Fax. +27 11 470 5494

South America: Rua do Rocio 220, 5th floor, Suite 51,
04552-903 São Paulo, SÃO PAULO - SP, Brazil,
Tel. +55 11 821 2333, Fax. +55 11 829 1849

Spain: Balmes 22, 08007 BARCELONA,
Tel. +34 3 301 6312, Fax. +34 3 301 4107

Sweden: Kottbygatan 7, Akalla, S-16485 STOCKHOLM,
Tel. +46 8 632 2000, Fax. +46 8 632 2745

Switzerland: Allmendstrasse 140, CH-8027 ZÜRICH,
Tel. +41 1 488 2686, Fax. +41 1 481 7730

Taiwan: Philips Semiconductors, 6F, No. 96, Chien Kuo N. Rd., Sec. 1,
TAIPEI, Taiwan Tel. +886 2 2134 2865, Fax. +886 2 2134 2874

Thailand: PHILIPS ELECTRONICS (THAILAND) Ltd.,
209/2 Sanpavuth-Bangna Road Prakanong, BANGKOK 10260,
Tel. +66 2 745 4090, Fax. +66 2 398 0793

Turkey: Talatpasa Cad. No. 5, 80640 GÜLTEPE/ISTANBUL,
Tel. +90 212 279 2770, Fax. +90 212 282 6707

Ukraine: PHILIPS UKRAINE, 4 Patrice Lumumba str., Building B, Floor 7,
252042 KIEV, Tel. +380 44 264 2776, Fax. +380 44 268 0461

United Kingdom: Philips Semiconductors Ltd., 276 Bath Road, Hayes,
MIDDLESEX UB3 5BX, Tel. +44 181 730 5000, Fax. +44 181 754 8421

United States: 811 East Arques Avenue, SUNNYVALE, CA 94088-3409,
Tel. +1 800 234 7381

Uruguay: see South America

Vietnam: see Singapore

Yugoslavia: PHILIPS, Trg N. Pasica 5/v, 11000 BEOGRAD,
Tel. +381 11 625 344, Fax. +381 11 635 777

For all other countries apply to: Philips Semiconductors, Marketing & Sales Communications,
Building BE-p, P.O. Box 218, 5600 MD EINDHOVEN, The Netherlands, Fax. +31 40 27 24825

Internet: <http://www.semiconductors.philips.com>

© Philips Electronics N.V. 1997

SCA54

All rights are reserved. Reproduction in whole or in part is prohibited without the prior written consent of the copyright owner.

The information presented in this document does not form part of any quotation or contract, is believed to be accurate and reliable and may be changed without notice. No liability will be accepted by the publisher for any consequence of its use. Publication thereof does not convey nor imply any license under patent- or other industrial or intellectual property rights.

Printed in The Netherlands

137087/1200/02/pp12

Date of release: March 1997

Document order number: 9397 750 02275

Let's make things better.

Philips
Semiconductors



PHILIPS